

## **Covid-19 Patient Breath Monitoring and Assessment with Mems Accelerometer-Based Daq - a Machine Learning Approach**

**Kalyan Dusarlapudi<sup>1</sup> ,K Narasimha Raju<sup>2</sup>, Venkata Siva Kumari Narayanam<sup>3</sup>**

<sup>1</sup> Assistant Professor, Department of Electrical and Electronics, KoneruLakshmaiah Education Foundation, Vaddeswaram, A.P., India.

<sup>2</sup> Professor, Department of Electrical and Electronics, KoneruLakshmaiah Education Foundation, Vaddeswaram, A.P., India.

<sup>3</sup> Venkata Siva Kumari Narayanam, Assistant Professor, Communication and Soft Skills department, KoneruLakshmaiah Education Foundation, Vaddeswaram, A.P, India  
corresponding mail: kalyandusarlapudi@kluniversity.in

### **Abstract:**

The coronavirus-2 infection, which emerged in 2019, is a severe illness that can cause acute respiratory failure and death. The effects of the coronavirus-2 disease on the respiratory system have been studied. This paper aims to develop a wearable device that can provide reliable and cost-effective respiratory monitoring. The hardware has been installed on COVID-19 infected individuals and healthy individuals. The study's goal is to find abnormalities in the data sets that can be used to estimate the respiration rate.

Keywords: COVID-19, Coronavirus,SVM, MEMS Accelerometer.

### **Introduction**

Due to epidemic of COVID-19 phase, many patients are reluctant to self-report their symptoms. It has led to the shortage of essential equipment and personnel in hospitals and intensive care units. In addition, it has necessitated the development of new remote patient monitoring techniques. Resting rate can aid in diagnosis and triage, as well as to identify patients who might be COVID-19. It is also a criterion for admission to the intensive care unit. In most cases, affected individuals with the disaster of COVID-19 respiratory or breathing issue require mechanical ventilation in the direction of inhibiting additional impairments of respiratory muscle deterioration, gas exchange, in addition to mortality [7].

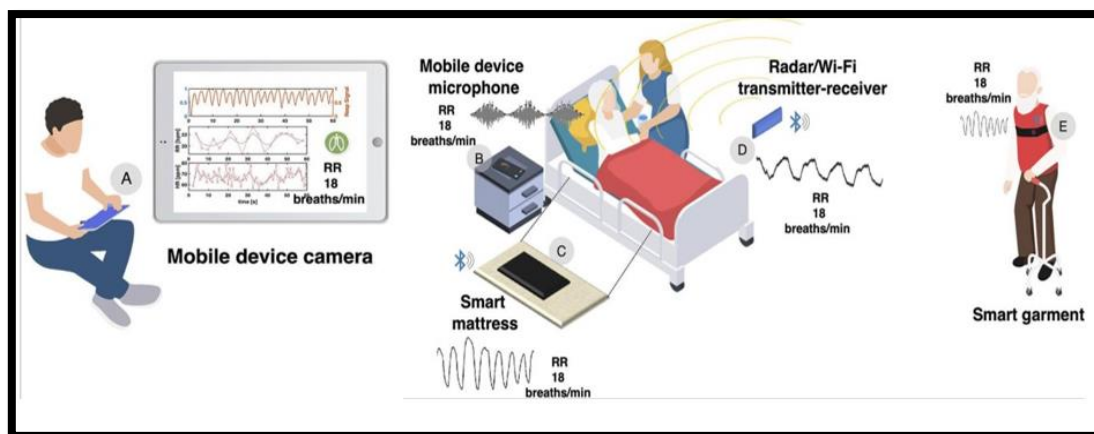

Fig.1. Respiratory data by Remote Logging with numerous technologies incorporated under monitoring stage

COVID-19 patients desire to use such technology in order to get assistance regarding the expertise that allow for remote R.R. control. As depicted in Figure 1(A) smart device technology with in-built camera utilised for tracking of R.R. caused by induced vibrations under walls of chest of respiratory system; or insignificant variations under patient's resting facial interjection. Figure 1(B) depicts smart device technology with in-built microphone utilised for R.R. recording as of breathing noises of patient's. Figure 1(C) depicts the continuous R.R. monitoring, for capturing patient's movements of chest wall under breathing-associated issues employing mechanised futon. Figure 1(D) depicted the movements of chest wall under the respiratory-associated modulation in transmitting the signals through radio wave signals or Wi-Fi signal sources and receiver towards apprehending the values of R.R. (nobody sensors are needed). [7]

## 1. Literature review

The literature describes a wearable device that can monitor respiratory rate using a low-power microcontroller. The computer is powered by a low-voltage MOSFET and runs on a motion-sensing algorithm. The device can also be used for long-term monitoring [1-2].

M. R. Ambedkar and S. Prabhu, two authors, proposed the new method [3]. Towards isolating the essential data of respiratory system through the signal of PPG, an EEMD method is presented. This method performs effectively with non-stationary signs. The findings produced with EEMD remain substantially improved when compared to EMD system, according to this research. The EEMD gadget captures respiratory images effectively. The total accuracy of the system is 97 percent. Therefore, the experimental findings proved that effectiveness of EEMD shows better range than EMD. Moreover, developed method [5] simulated using MATLAB with version of R2013.

## Methodology

Numerous methodologies are involved to compute or evaluate the respiration rate. Most frequently, a device which integrates the impedance-based pneumographic machinery, commonly the chest strap is utilised. The capnograph is a device that is frequently used in

hospitals to calculate breathing rates. Plethysmography is another technique for assessing respiratory rate that has been presented. The displacement of the diaphragm is usually computed using mechanical instruments such as strain gauge, magnetometer, barometer or gas pressure sensor and so forth. A photoplethysmogram or ECG waveform analysis can also be used to calculate the rate of breathing. However, these approaches obtain minimal precision, in addition to some which give rise to susceptibility under contamination of motion. Finally, the most important and crucial arena for treatment utilising such technology for dealing with affected individuals scattered across a vast geographic region involves the subject of telemedicine. A telemedicine gadget lets a doctor in one location treat a patient in another. In this study, acceleration is estimated in three perpendicular directions (using a non-contact device) (such as X, Y and Z) by employing the MEMS accelerometer. In addition, integrated with module of Bluetooth and Triaxial Accelerometer with the ADXL335 sensor for controlling the accelerations for each position wherever challenge is required towards the measurement of accelerations due to the inaccessibility of a limited zone where three accelerometers are not reachable.

## 2. Design of DAQ system

### 2.1 Block diagram

Embedded processors are used in the suggested hardware to extract respiratory data from healthy and COVID19 affected people. The Arduino Nano module was chosen for its compactness and incorporates the machinery that includes 433MHz ranging wireless transmitter as well as receiver, and accelerometer. Figure 2 depicts sections that make up a data collection system.

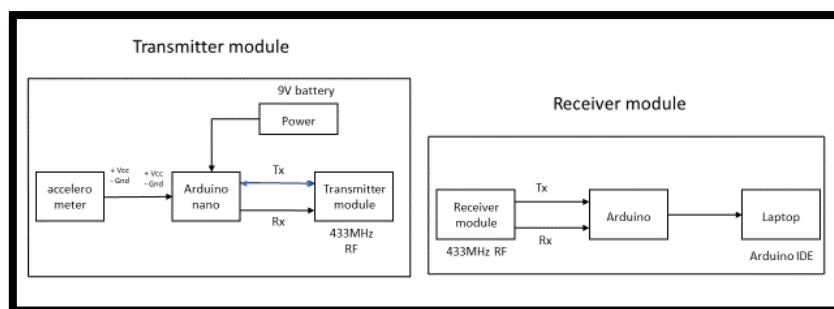

Fig.2. Block interpretation of Wireless DAQ system

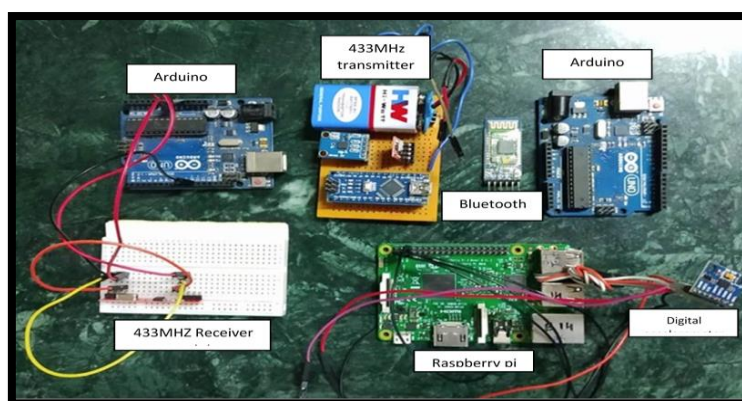

Fig.3. Wireless DAQ system components

Configuring with the features associated with ADXL335 of attaining three axial accelerometer that is monolithic. Its open-loop design allows the use of various analogue and digital signals. The device can also be used for tilt-sensing applications.

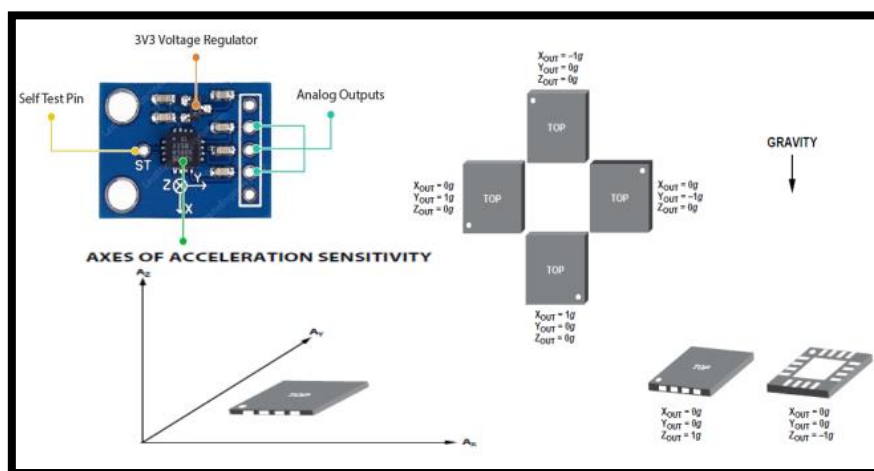

Fig.4. MEMS Accelerometer module

The instant connecting the ADXL335 accelerometer with standardised system combined to ill individuals' fronts, the Arduino Microcontroller is utilised for analysing the sensor data. Furthermore, PLXDAQ software receives data from the Arduino IDE's serial monitor and transmits it to a local computer. The data from the PLXDAQ programme is stored in the CSV files. The project's goal is to integrate the two data sets available. In which, initial data set involves about healthy individual, whereas later dataset deals with affected one's. Following that, several techniques are employed to compare the standard and suffering data sets. [6]

#### Experimental Setup:

The ADXL335 accelerometer circuit is straightforward, with no complex parts or wiring required. It connects to an Arduino directly. The following are the steps to link an Arduino Uno to an ADXL335 accelerometer: Connect the pin of Arduino's 5V to VCC, Ground to the GND pin, along with Arduino's analogue to the data outputs about the axis of X, Y, and Z within the sequence of A0, A1, and A2. Moreover, X, Y, and Z axes associates with the computation of acceleration using ADXL335 as well as produces an equal voltage representing the analogue value. Microcontrollers may use ADC to convert the voltages to digital signals, which can then be processed. The Wireless modules 433MHz R.F. transmitter and receiver are incorporated into the Arduino [10]. To connect the Arduino to Excel, utilize the software named Parallax Data Acquisition Tool (PLX-DAQ) package. Within the Microsoft Excel platform, it can be linked as free add-on service. Eight plus eleven years old Before the Arduino could be linked to Excel, it necessitates the installation in conjunction to software of Arduino (IDE). After Arduino code is uploaded, go to spreadsheet icon of PLX-DAQ. Following, choose for Arduino interface, look for located in box of Download Data, then get on Link. Subsequently, line graph will be incorporated with the interpretation of charting real-time execution.

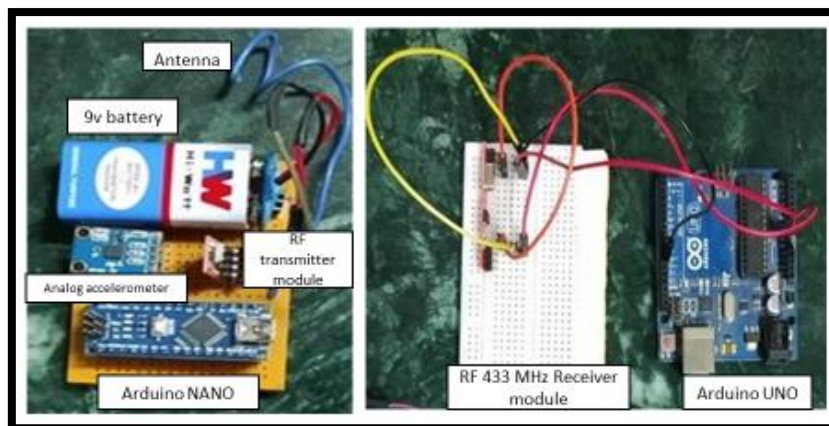

Fig.5. Wireless DAQ schememodules ofTx and Rx

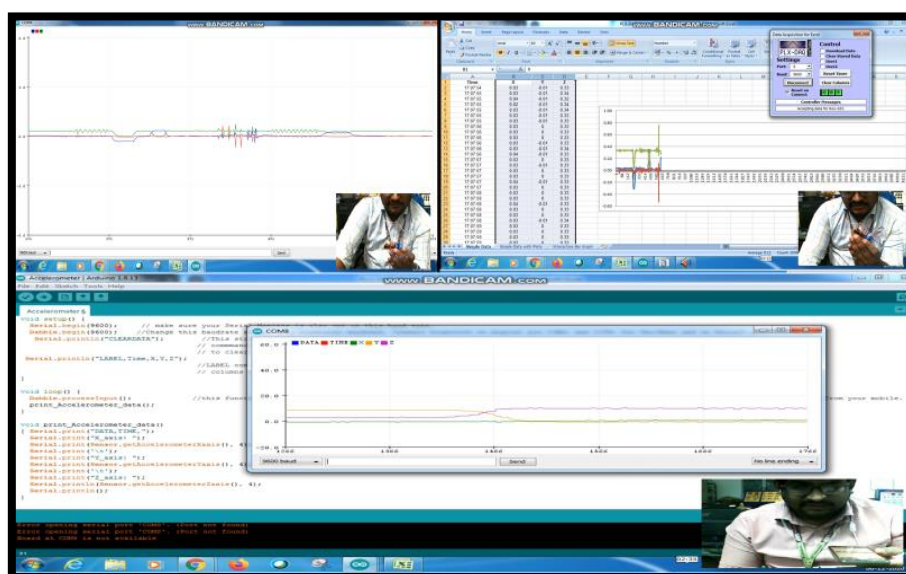

Fig.6. Mobile application incorporated with the plotting of Real-time mapping of Tx, Rx modules

To record the data from the accelerometer sensor, the utilization of mobile application is necessary which will be placed over the abdomen. The program also supports multi-sensor recording. It provides a full view of the various actions taken by the sensors when combined in Fig 6.

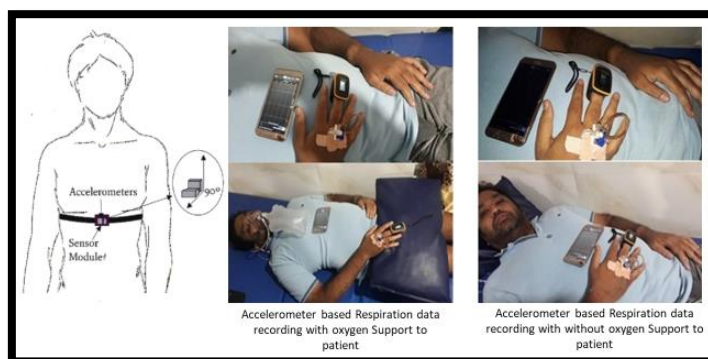

Fig.7. Mobile application incorporated with the plotting of Real-time mapping of Tx, Rx modules



To build a system for identifying the abnormalities existing in data, the utilization of sensor's data is essential. The answer would be to employ unsupervised learning techniques since the data employed is real-time and natural. Moreover, available data isn't is labelled. The goal is to develop a way to show whether there are any anomalies in the findings. If an abnormality is discovered, the research defines the person's health condition whose data is being studied. The project uses the One-Class SVM method on the target data. Employs the algorithm which is unsupervised performs improved when compared with data that is unlabeled. The one-class technique is used to find the judgement surface over the data.

### 3. Results and Discussion

A 3-axis accelerometer and an integrated microcontroller to collect and interpret respiration data. The data can then be analyzed with a machine learning technique to detect abnormal patterns.

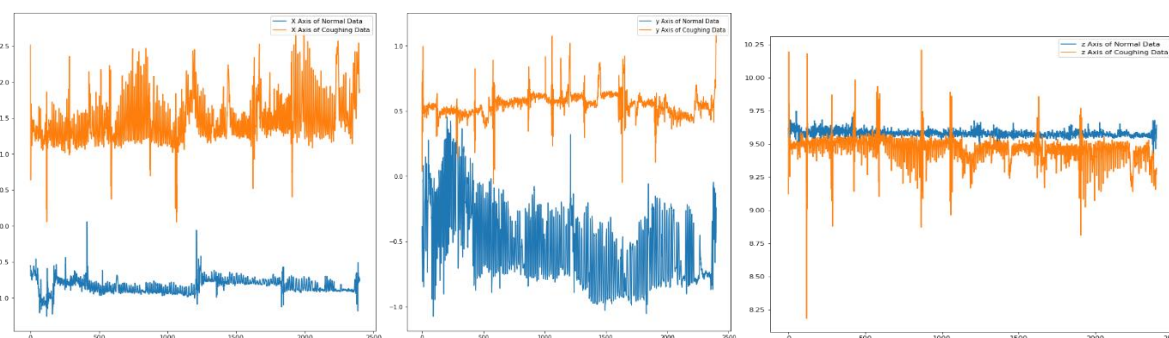

Fig.8. Normal person's and Covid patient's data in all the three axis (X, Y & Z)

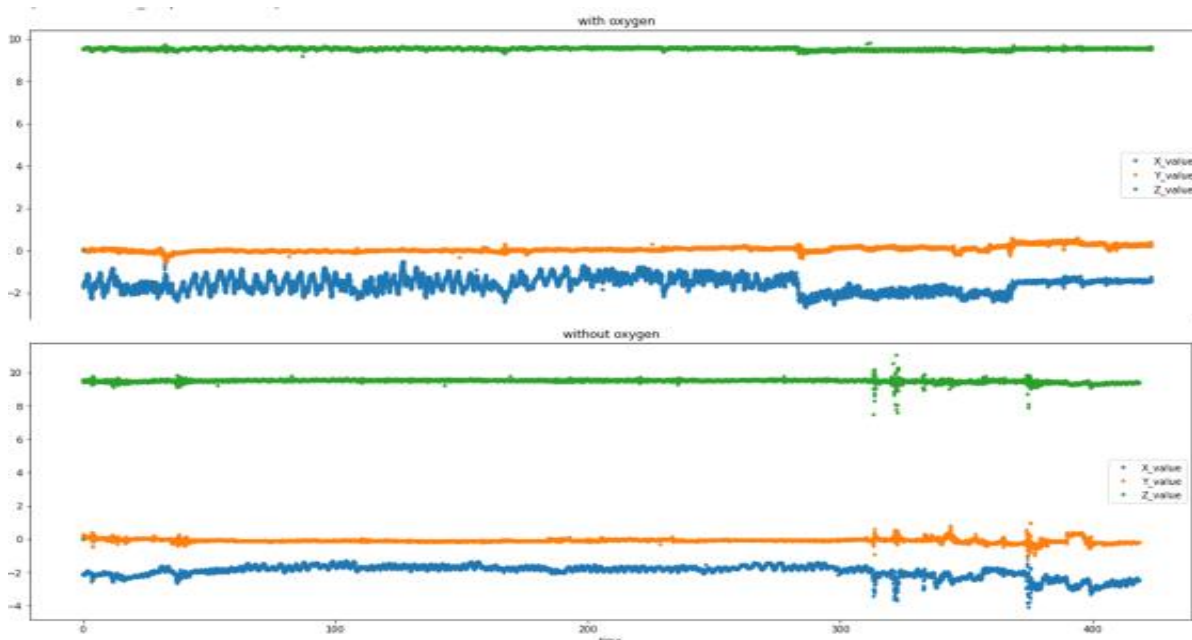

Fig.8. Covid patient's Sensor Data in presence and absence of oxygen

Comparison is made for accelerometer data with intended hardware data from a mobile phone to verify performance of the sensor and the monitored person. Moreover, from the

statical analysis it is observed that x-axis data reached superior standard in comparison to remianing axes.

Parameters	Time	X_Axis	Y_Axis	Z_Axis
Count	2400	2400	2400	2400
Mean	316.7	-0.84	-0.56	9.59
Std	182.84	0.10	0.29	0.24
Min	0.10	-1.26	-1.07	9.42
Max	633.10	0.050	0.450	9.70

Table.1. Statistical details of Normal Person of 3 axes accelerometer

Parameters	Time	X-Axis	Y-Axis	Z-Axis
Count	2400	2400	2400	2400
Mean	315.8	1.470	0.549	9.460
Std	192.873	0.315	0.080	0.102
Min	0.178	0.053	-0.059	8.190
Max	633.270	2.760	1.139	10.303

Table.2. Statistical details of Covid-19 Patientof 3 axes accelerometer

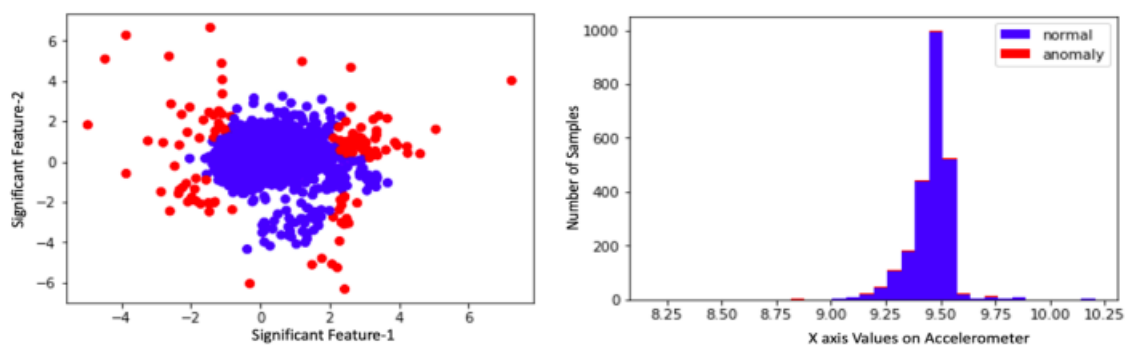

Fig.9. Two data sets anomalies using Scatter plot and histogram

The one-class SVM method is a commonly used framework to analyze coughing data. It uses Python programming language to implement an anomaly detection technique that learns from the data. It produces graph plots with red lines to represent deviations. This project aims to use the notion of telemedicine to build an internet application that allows a doctor and a patient to consult remotely [4]. To view their report and doctor's prescription, it is evident that individual patient themselves enable their account in the platform of online web

application. Following, the doctor downloads the medicine to the selected patient at the instant the administrator holding information directs to the network programme with reports that are recorded. As a result, real-time data monitoring assists doctors in diagnosing patients before they deteriorate [8] [9].

## Conclusion

With response towards COVID-19 pandemic period, the use of precision remote patient monitoring is expected to play a critical role. This technology can help minimize the isolation of COVID-19 patients and improve the quality of healthcare available to them. This study aims to develop a method to reduce the likelihood of hospital infections by using real-time blood data. In addition, this method would allow the development of accurate diagnostic and prognostic models. The findings also indicated that remote R.R. monitoring is very beneficial in detecting COVID-19 events and other critical factors. However, this goal should be met with the right tools and technologies.

## References:

1. Preejith S pi, Ahamed JeeJanil, Paresh Maniyarl, JayarajJosephl and MohanasankSivaprakasam"Accelerometer Based System for Continuous Respiratory Rate Monitoring" IEEE Instrumentation Measurement Society 2017
2. S. Fleming et al., "Normal ranges of heart rate and respiratory rate in children from birth to 18 years of age: a systematic review of observational studies," *The Lancet*, vol. 377, no. 9770, pp. 1011-1018, Mar. 2011.
3. M. R. Ambekar and S. Prabhu, "A Novel Algorithm to Obtain Respiratory Rate from the PPG Signal," *International Journal of Computer Applications*, vol. 126, no. 15, 2015.
4. Andrew Bates, Martin Ling, Christian Gengy, Alice Turkey and D. K. Arvind" Accelerometer-based respiratory measurement during speech" 2011 International Conference on Body Sensor Networks
5. P.D. HUNG<sup>1,2</sup>, S. BONNET<sup>1</sup>, R. GUILLEMAUD<sup>1</sup>, E. CASTELLI<sup>2</sup>, P. T. N. YEN<sup>2</sup> "Estimation of respiratory waveform using an accelerometer" IEEE International Symposium on Biomedical Imaging June 2008.
6. Dusarlapudi, K., Narasimha Raju, K., "Embedded prototype of 3 DOF parallel manipulator for endoscope application using 3 axis MEMS accelerometer", *Journal of Advanced Research in Dynamical and Control Systems*, Vol 12, issue 2, 1225-35, Mar 2020.
7. Uday Kiran, K., Shakeela, S., Kalyan, D., ...Sai Chaitanya, G., Ekanath Reddy, G., Detection of abnormalities in covid-19 infected human respiratory system using accelerometer with the aid of machine learning, *International Journal of Pharmaceutical Research*, 2020, 12(4), pp. 3399–3407.
8. Preeti, M., Guha, K., Baishnab, K.L., Dusarlapudi, K., Narasimha Raju, K., Low frequency MEMS accelerometers in health monitoring – A review based on material and design aspects, *Materials Today: Proceedings*, 2019, 18, pp. 2152–2157.
9. Narayana, M.V., Dusarlapudi, K., Uday Kiran, K., Sakthi Kumar, B., IoT based real time neonate monitoring system using Arduino, *Journal of Advanced Research in Dynamical and Control Systems*, 2017, 9(Special issue 14), pp. 1764–1772.
10. Kalyan Dusarlapudi, K Narasimha Raju, Preeti M, ASCS Sastry, Genesis of MEMS Accelerometers for Select the Optimal Accelerometer for Bio Applications, *International Journal of Innovative Technology and Exploring Engineering*, 2019, Volume-9 Issue-2, December 2019